

**PLAN**

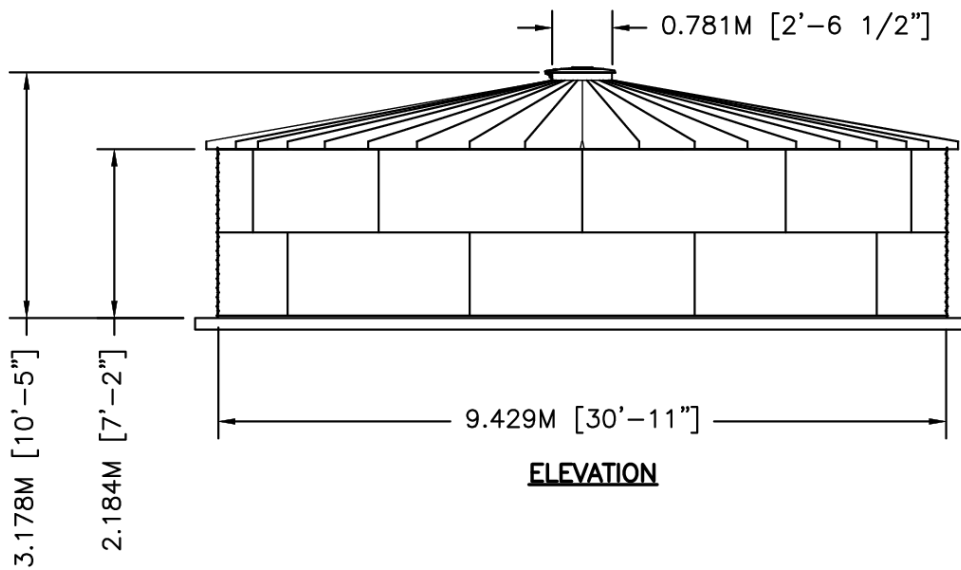

**ELEVATION**



	BY	DATE	TITLE	
DWN	XXX	XX/XX/XX	WTU10-02 30"PR 10DEG V-RIB	
CKD			NOMINAL CAPACITY - 143.668 M3 [37,953 GAL]	
ENG			DWG. NO. SCT3002-LVR WTU10-02	REV. NO.
SIZE:	A	SCALE:	1/8"=1'-0"	SHEET 1 OF 1